

Fig. 3

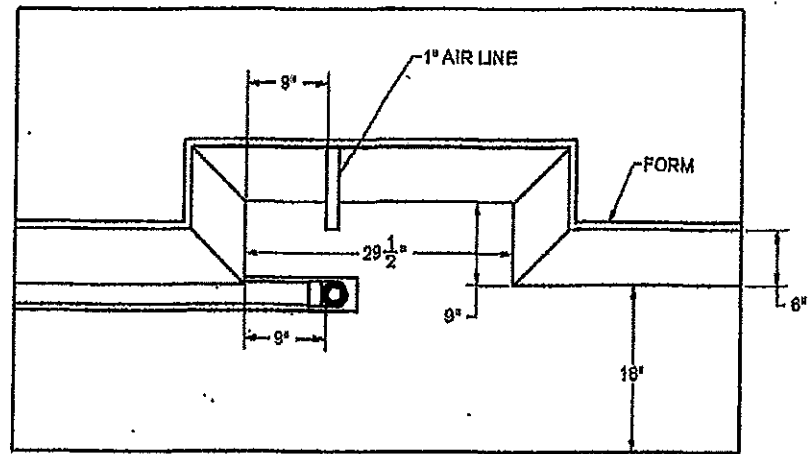

Fig. 2

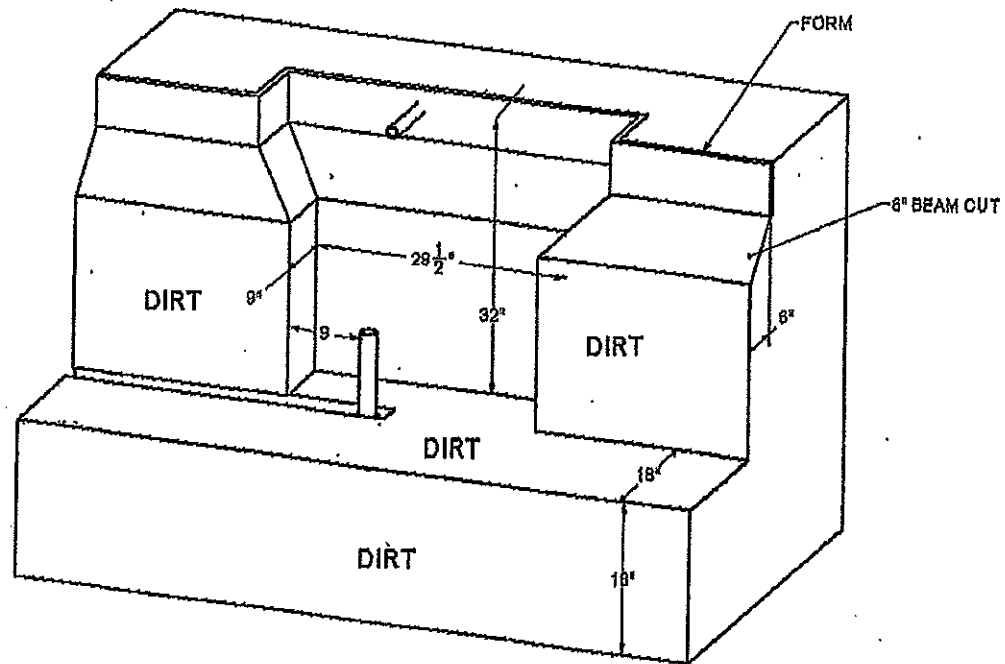

Fig. 1